

SEAL HOLDER

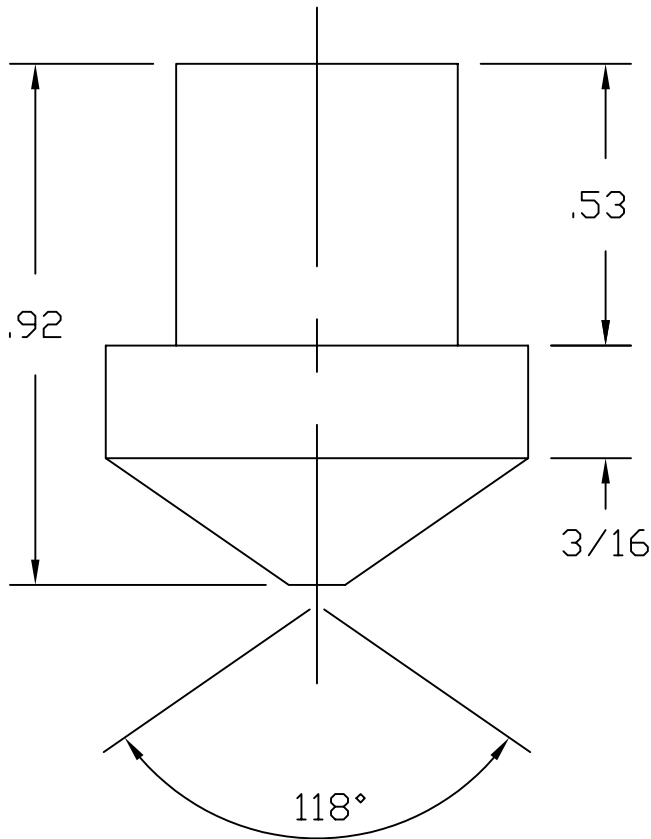
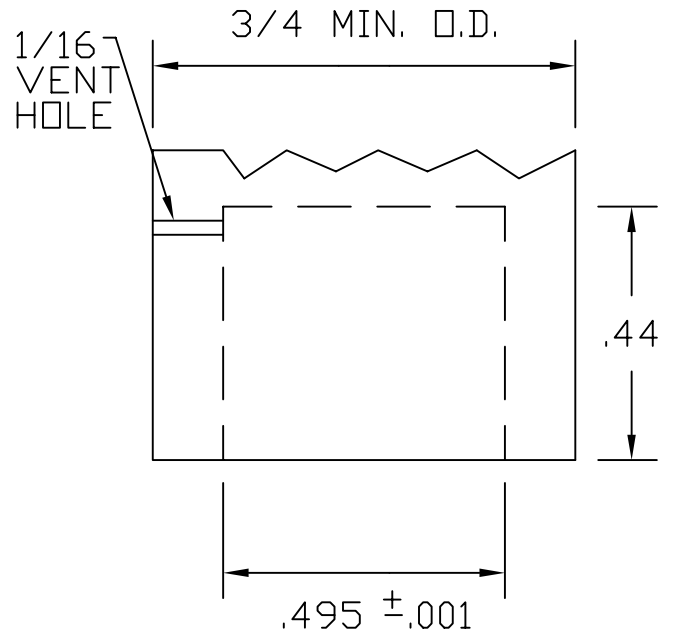

CINCINNATI TEST SYSTEMS, INC.  
5555 DRY FORK RD. CLEVELAND, OH 45002

PHONE 513-367-6699

FAX 513-367-5426

SEAL

CTS-11B

DATE

11-07-97