

SECTION A-A
SCALE 3 : 2

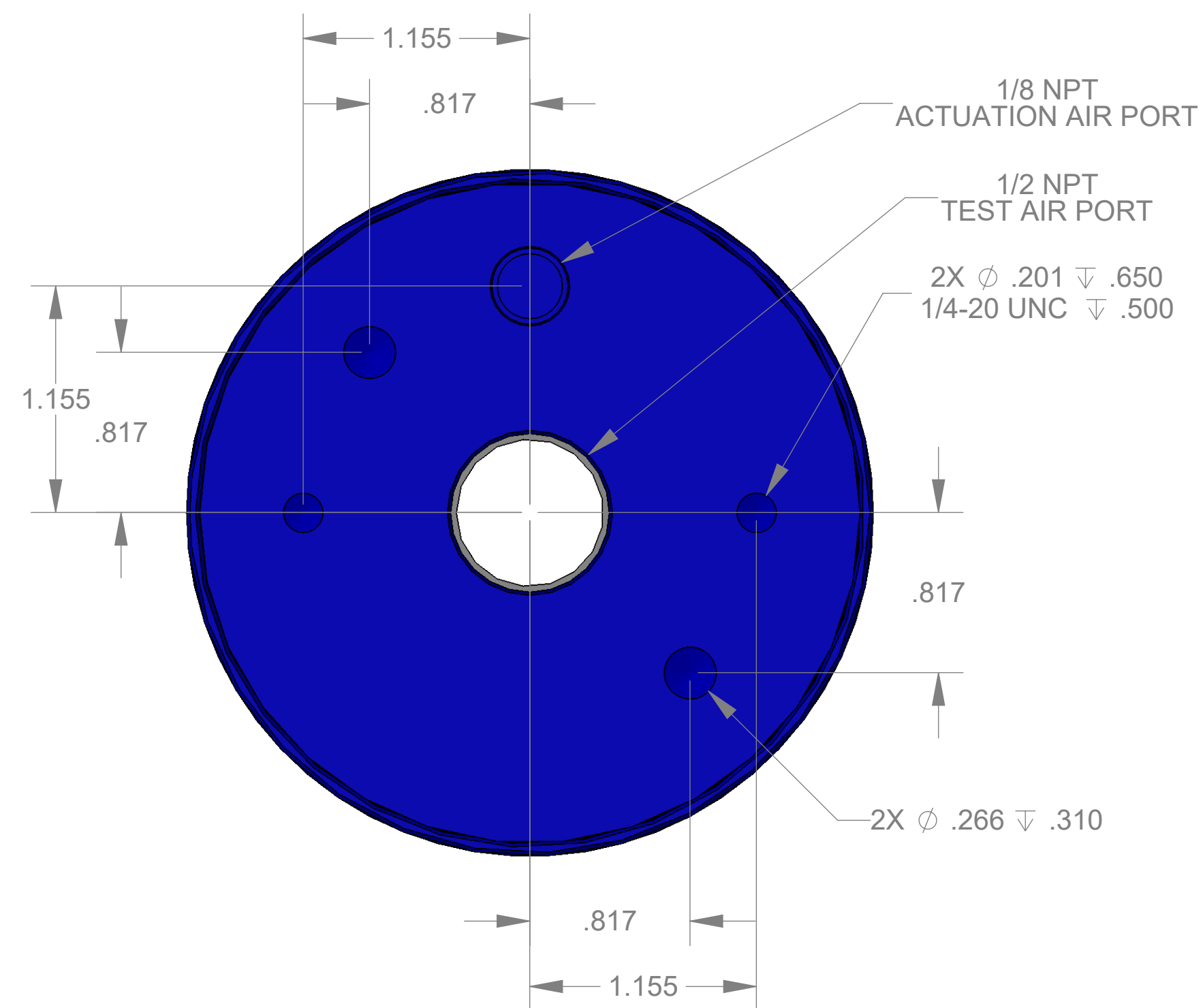

ITEM NO.	PART NUMBER	DESCRIPTION	QTY.
10	MACH-004186	Body, CTS, CI36	1
20	MACH-004253	Cap, CTS, CI36	1
30	MACH-054225	Stem, CTS, CI36-E2.0	1
40	SEAL-005439	CI36-ORING 217	1
50	SEAL-005443	CI35-ORING 337	1
60	MACH-050251	Nose, CTS, CI36-SAE-2000	1
70	MACH-050252	Washer, CTS, CI36-SAE-2000	1
80	MACH-004598	Spacer Extension, CTS, CI36	2
90	SEAL-053983	Face Seal, CTS, CI36-SAE-2000	1
100	SEAL-047820	Thread Seal, CTS, CI36-SAE-2000	1
110	SEAL-053988	Thread Seal, CTS, CI36-SAE-2000	1



REVISIONS			
REV.	DESCRIPTION	DATE	APPROVED
A	Initial Release	04-06-2026	KM
B	Nose material changed from brass to 316 stainless steel	04-06-2026	KM



SIZE	DESCRIPTION			
D	Connect Assembly, CTS, CI36-SAE-2000-E2.0			
PART NUMBER	REV			
CTSC-002719	B			
DATE	DRAWN BY	CHECKED BY	SHEET	OF
11/04/05	KM	KM	1	1

FILE LOCATION: C:\PDM\PDM\R&D Product Development\CTS Connects\CI\Connect Assembly\Standard\CI36\2in Stem Extension\CTSC-002719

Monday, April 6, 2026