

SECTION A-A
SCALE 2 : 1

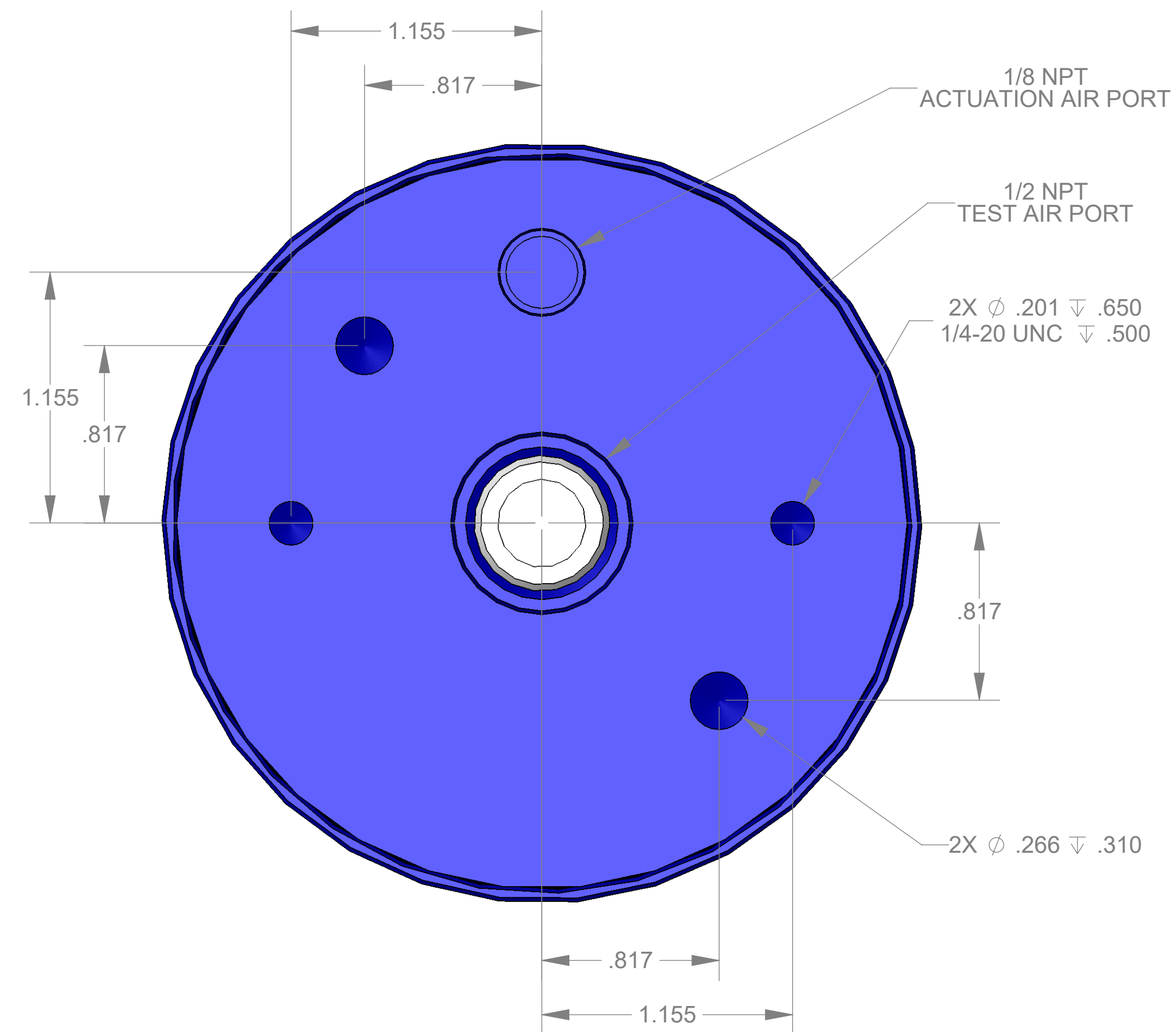

ITEM NO.	PART NUMBER	DESCRIPTION	QTY.
10	MACH-004185	Body, CTS, CI35	1
20	MACH-004252	Cap, CTS, CI35	1
30	MACH-054219	Stem, CTS, CI35-E1.0	1
40	SEAL-005449	CI35-ORING 210	1
50	SEAL-005443	CI35-ORING 337	1
60	MACH-042121	Nose, CTS, CI35-SAE-1750	1
70	MACH-042122	Washer, CTS, CI35-SAE-1750	1
80	MACH-004592	Spacer Extension, CTS, CI35	1
90	SEAL-042155	Seal, CTS, CI35-SAE-1750	1



REVISIONS			
REV.	DESCRIPTION	DATE	APPROVED
A	Initial Release	04-02-2026	KM
B	Nose material changed from brass to 316 stainless steel	04-06-2026	KM



SIZE	DESCRIPTION			
D	Connect Assembly, CTS, CI35-SAE-1750-E1.0			
PART NUMBER	REV			
CTSC-002662	B			
DATE	DRAWN BY	CHECKED BY	SHEET	OF
11/04/05	KM	KM	1	1

FILE LOCATION: C:\PDM\PDM\R&D Product Development\CTS Connects\CI\Connect Assembly\Standard\CI35\1in Stem Extension\CTSC-002662

Monday, April 6, 2026