

SECTION A-A
SCALE 3:2

ITEM NO.	PART NUMBER	DESCRIPTION	QTY.
10	MACH-004185	Body, CTS, CI35	1
20	MACH-004252	Cap, CTS, CI35	1
30	MACH-054221	Stem, CTS, CI35-E2.0	1
40	SEAL-005449	CI35-ORING 210	1
50	SEAL-005443	CI35-ORING 337	1
60	MACH-004344	Nose, CTS, CI35-SAE-1625	1
70	MACH-004464	Washer, CTS, CI35-SAE-1625	1
80	MACH-004592	Spacer Extension, CTS, CI35	2
90	SEAL-004932	Seal, CTS, CI35-SAE-1625	1

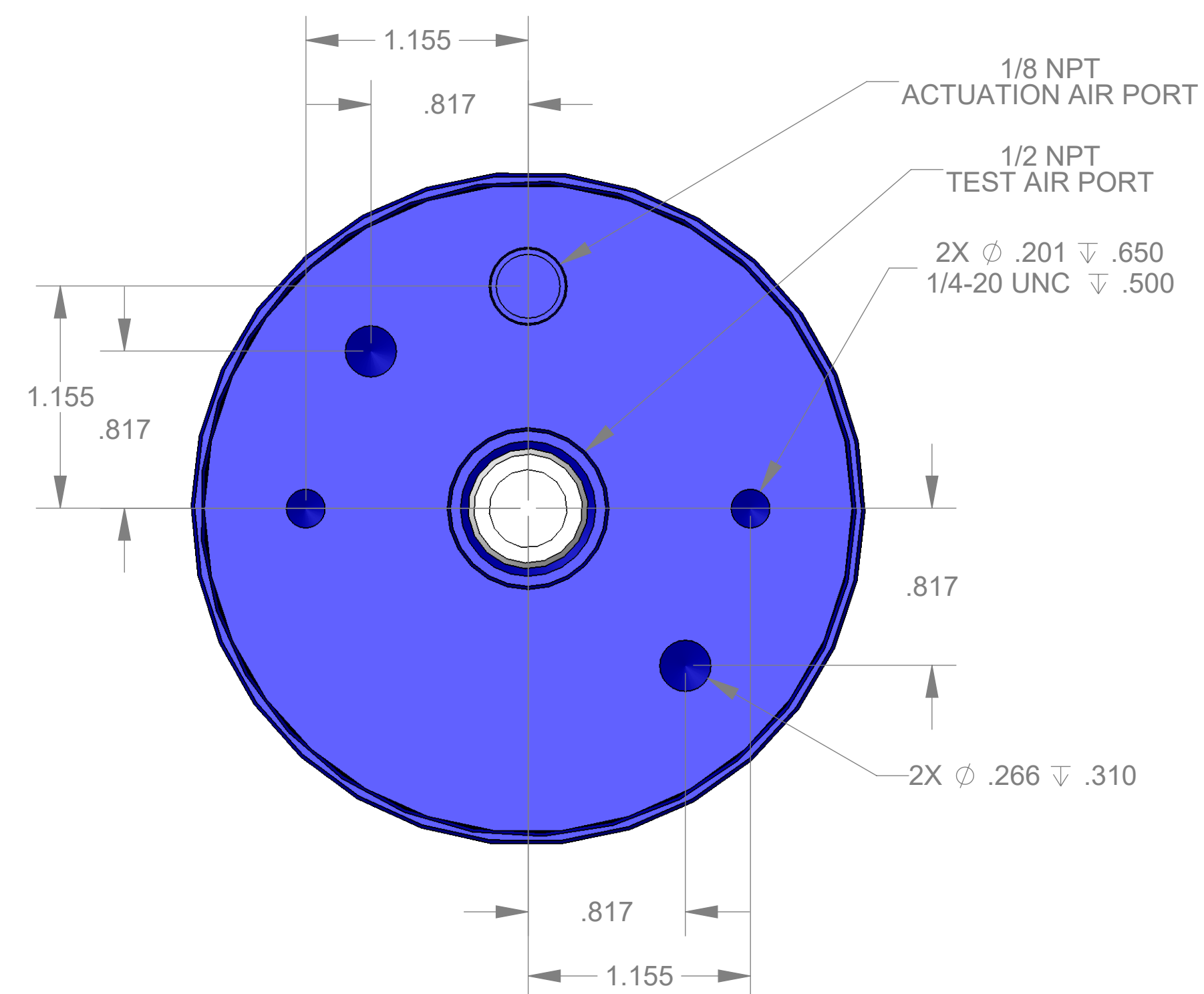

REVISIONS			
REV.	DESCRIPTION	DATE	APPROVED
A	Initial Release	04-02-2026	KM
B	Nose material changed from brass to 316 stainless steel	04-06-2026	KM

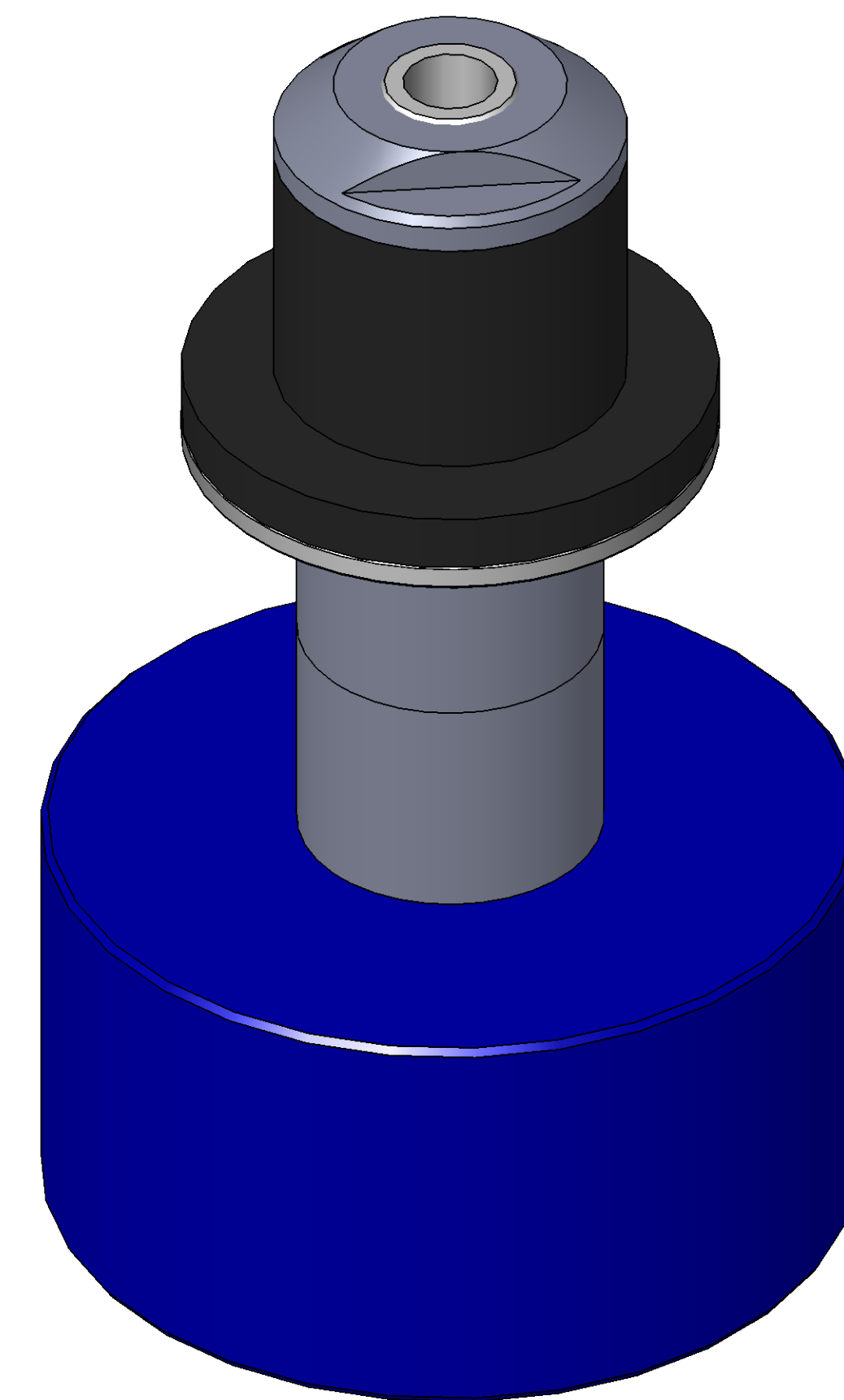

10100 PROGRESS WAY HARRISON, OH 45030

SIZE	DESCRIPTION			
D	Connect Assembly, CTS, CI35-SAE-1625-E2.0			
PART NUMBER	REV			
CTSC-002635	B			
DATE	DRAWN BY	CHECKED BY	SHEET	OF
11/04/05	KM	KM	1	1

FILE LOCATION: C:\PDM\PDM\R&D Product Development\CTS Connects\CI\Connect Assembly\Standard\CI35\2in Stem Extension\CTSC-002635