

SECTION A-A
SCALE 3 : 2

ITEM NO.	PART NUMBER	DESCRIPTION	QTY.
10	MACH-004190	Body, CTS, CI40	1
20	MACH-004257	Cap, CTS, CI40	1
30	MACH-054235	Stem, CTS, CI39/40-E3.0	1
40	MACH-004604	Spacer, CTS, CI39/40	1
50	SEAL-005442	CI39-ORING 226	1
60	SEAL-005445	CI40-ORING 346	1
70	MACH-004373	Nose, CTS, CI40-AD	1
80	SEAL-005023	Seal, CTS, CI40-AD	3
90	MACH-004489	Washer, CTS, CI40-AD	1
100	MACH-004605	Spacer Extension, CTS, CI39-CI40	3

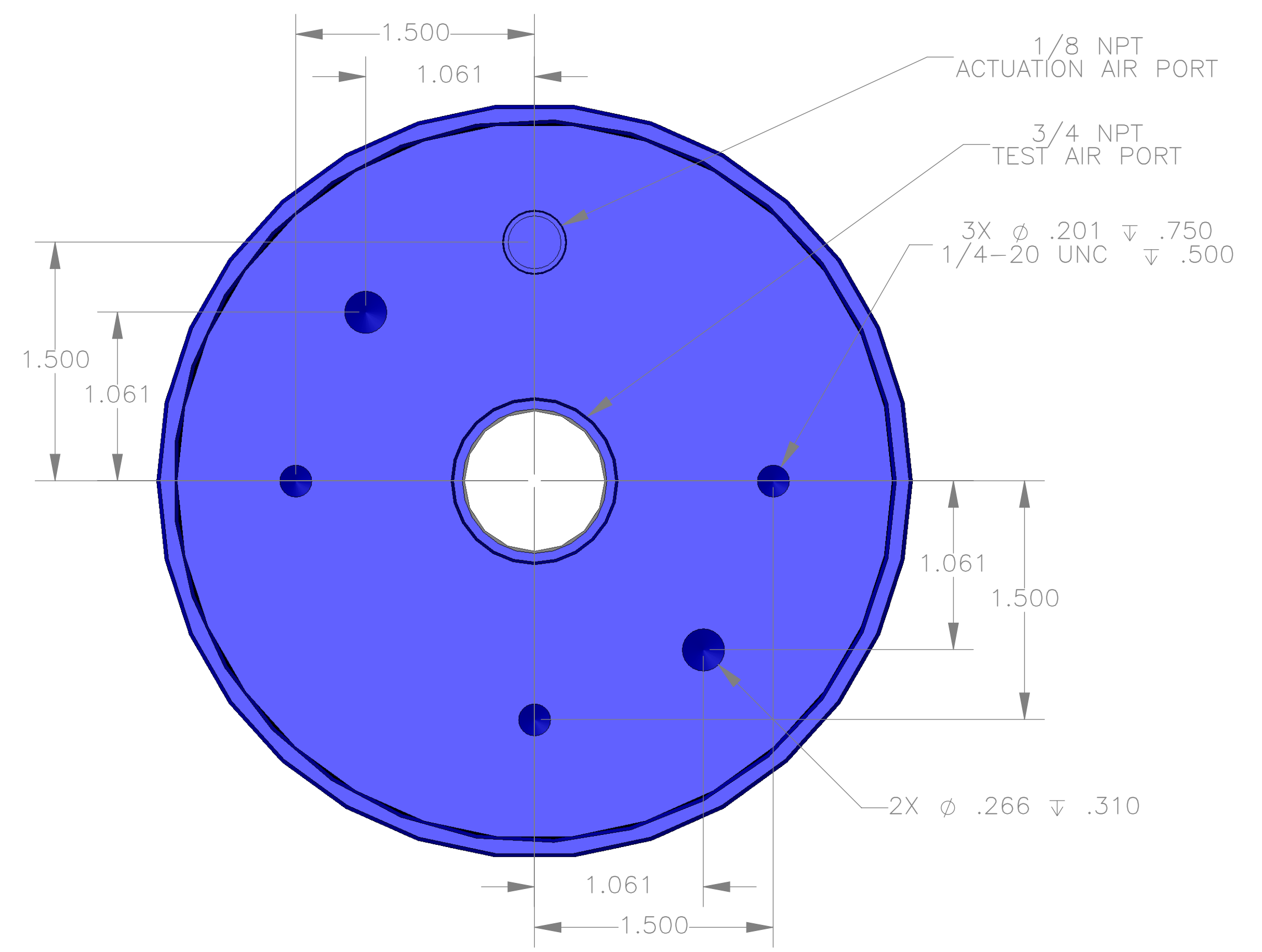

REVISIONS			
REV.	DESCRIPTION	DATE	APPROVED
A	Initial Release	03-11-2026	KM
B	Nose material changed from brass to 316 stainless steel	03-12-2026	KM

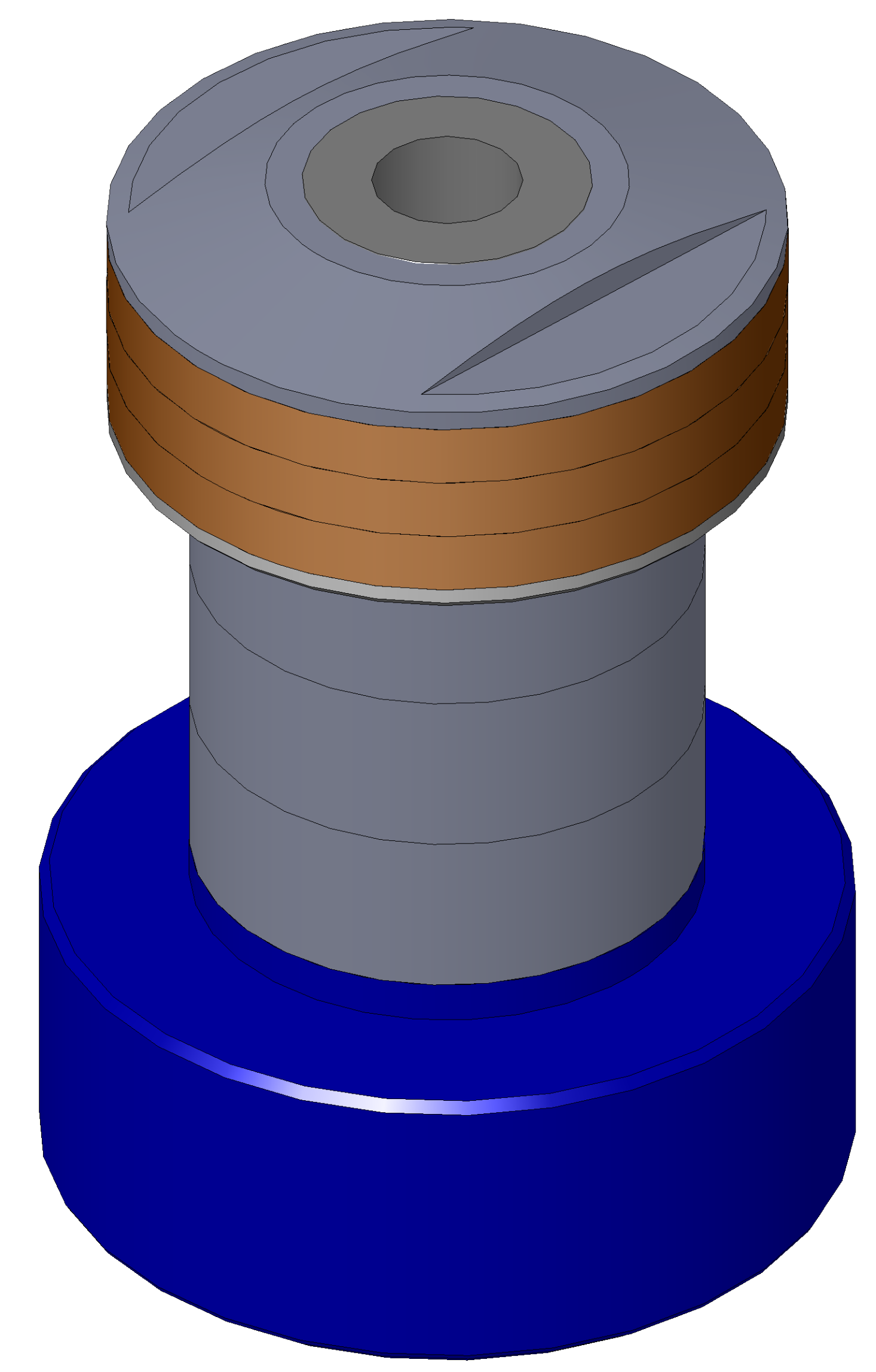

SIZE	DESCRIPTION	REV
D	Connect Assembly, CTS, CI40-AD-E3.0	B
PART NUMBER		REV
CTSC-002104		B
DATE	DRAWN BY	CHECKED BY
8/12/05	KM	KM
SHEET		OF
1		1

FILE LOCATION: C:\PDM\PDM\R&D Product Development\CTS Connects\CI\Connect Assembly\Standard\CI40\3in Stem Extension\CTSC-002104

Thursday, March 12, 2026