

SECTION A-A
SCALE 3 : 2

ITEM NO.	PART NUMBER	DESCRIPTION	QTY.
10	MACH-004185	Body, CTS, CI35	1
20	MACH-004252	Cap, CTS, CI35	1
30	MACH-054221	Stem, CTS, CI35-E2.0	1
40	MACH-004591	Spacer, CTS, CI35	1
50	SEAL-005449	CI35-ORING 210	1
60	SEAL-005443	CI35-ORING 337	1
70	MACH-004340	Nose, CTS, CI35-AB	1
80	SEAL-004916	Seal, CTS, CI35-AB-M	3
90	MACH-004461	Washer, CTS, CI35-AB	1
100	MACH-004592	Spacer Extension, CTS, CI35	2

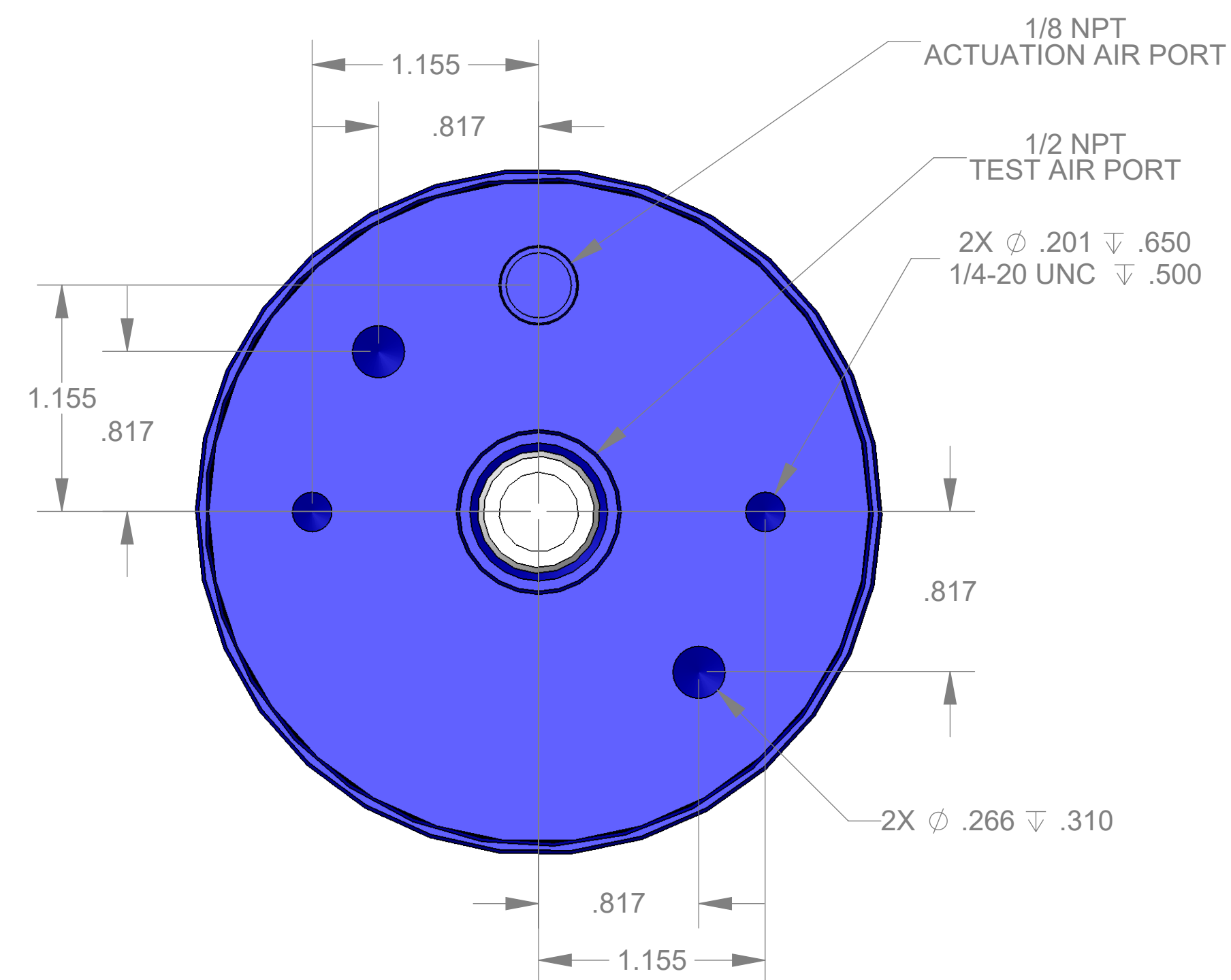

REVISIONS			
REV.	DESCRIPTION	DATE	APPROVED
A	Initial Release	03-16-2026	KM
B	Changed material of nose and seal	03-17-2026	KM

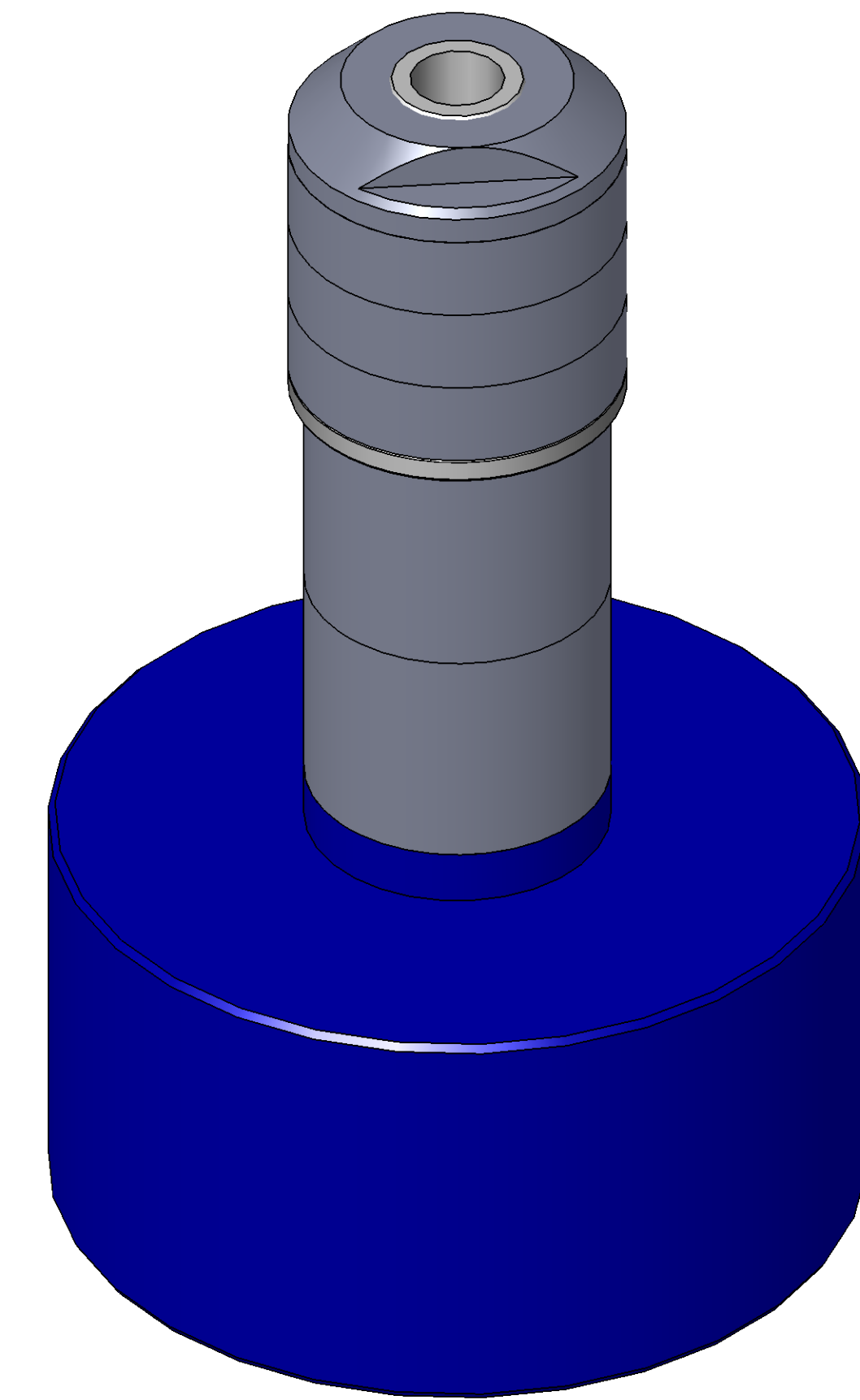

10100 PROGRESS WAY HARRISON, OH 45030

SIZE	DESCRIPTION	REV
D	Connect Assembly, CTS, CI35-AB-E2.0-M	B
PART NUMBER	CTSC-001789	
DATE	DRAWN BY: KM	CHECKED BY: KM
	SHEET 1	OF 1