

SECTION A-A

ITEM NO.	PART NUMBER	DESCRIPTION	QTY.
10	MACH-004183	Body, CTS, CI33	1
20	MACH-004250	Cap, CTS, CI33	1
30	MACH-054211	Stem, CTS, CI33-E1.0	1
40	MACH-004585	Spacer, CTS, CI33	1
50	SEAL-005437	CI33-ORING 113	1
60	SEAL-005441	CI33-ORING 225	1
70	MACH-004316	Nose, CTS, CI33-AA	1
80	SEAL-004850	Seal, CTS, CI33-AA-M	2
90	MACH-004444	Washer, CTS, CI33-AA	1
100	MACH-004586	Spacer Extension, CTS, CI33	1

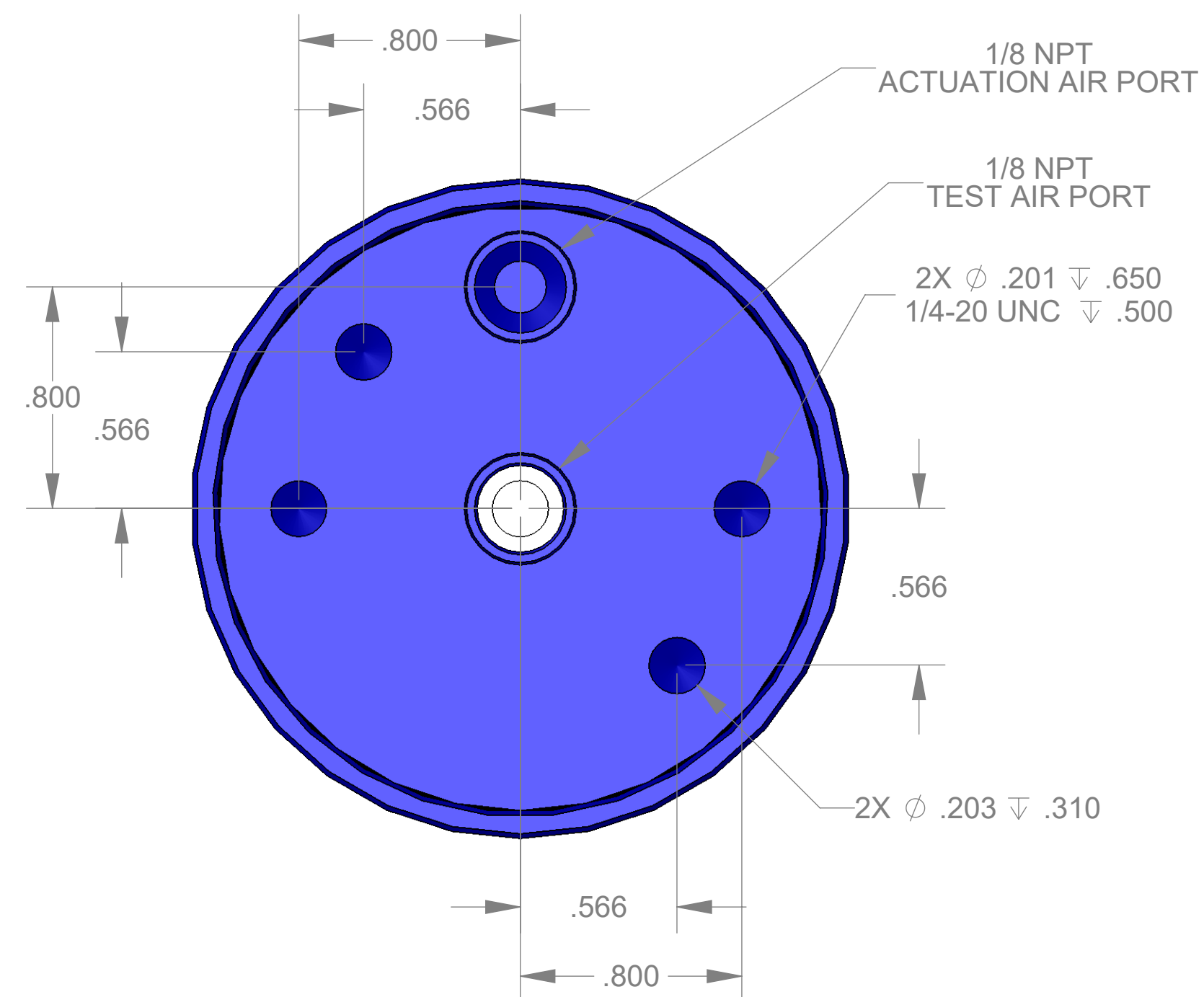

REVISIONS			
REV.	DESCRIPTION	DATE	APPROVED
A	Initial Release	01-30-2026	KM
B	Changed material of nose and seal	03-16-2026	KM

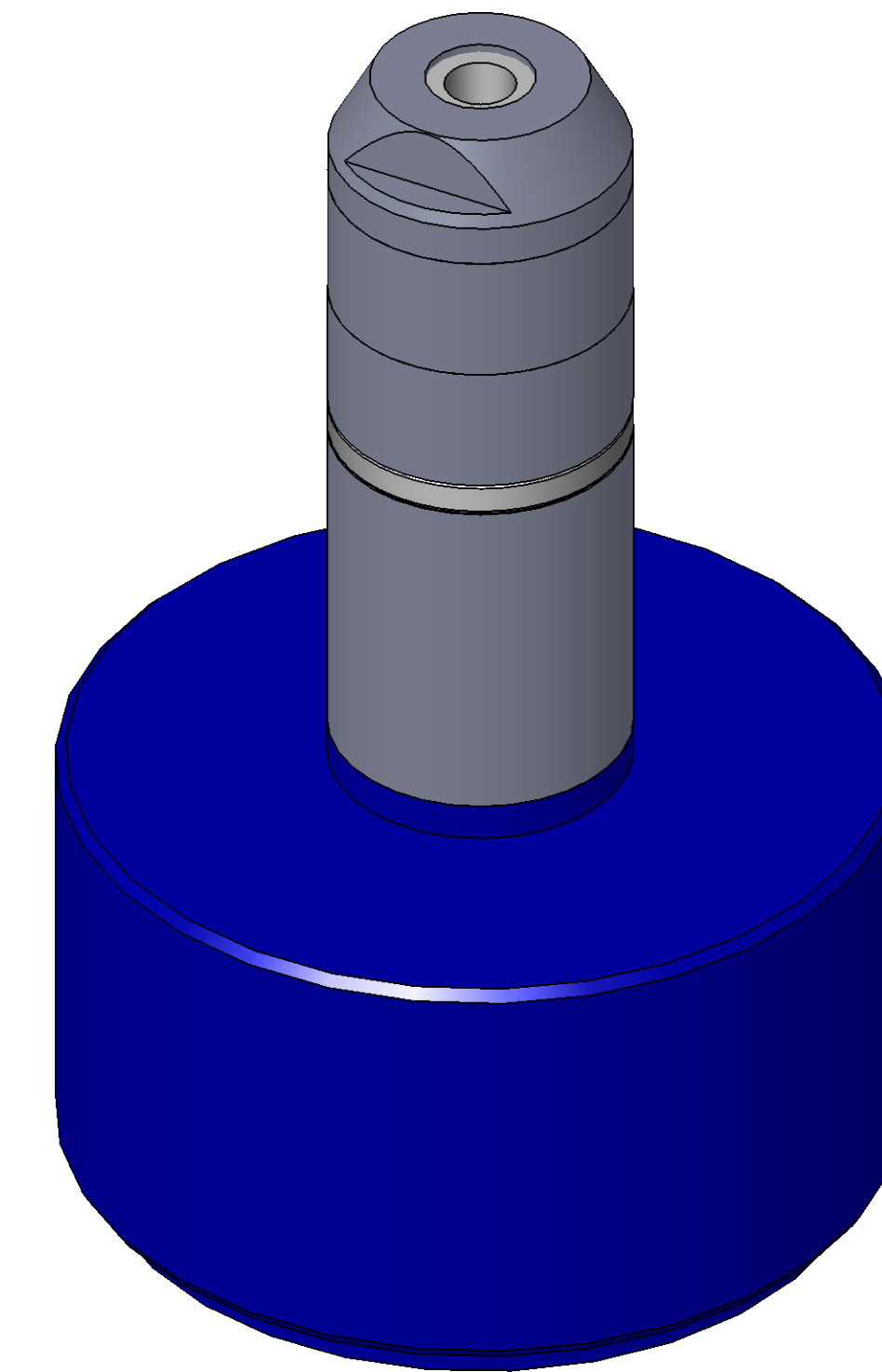

10100 PROGRESS WAY HARRISON, OH 45030

SIZE	DESCRIPTION	REV
D	Connect Assembly, CTS, CI33-AA-E1.0-M	B
PART NUMBER	CTSC-001652	
DATE	DRAWN BY: KM	CHECKED BY: KM
	SHEET 1	OF 1